



Rainbow Pool Products

PO Box 2388, Mansfield Qld 4122

Telephone STD 61-7-3849 5385

Facsimile STD 61-7-3849 5384

Email: info@rainbowpoolproducts.com.au

Web: www.rainbowpoolproducts.com.au

WATERCO
water, the liquid of life

EXOTUF PLUS Filter

Superior Strength, Dependability & Environmentally Friendly Media Filter

The Exotuf Plus media filters are designed to cope with the cyclic pressures of the modern day swimming pool and feature hydraulically efficient fish tail lateral systems in both top and side-mount models which facilitate energy and water savings.

- Water savings of up to 30%
- Ideal for low powered and energy efficient pumps
- Multiport valve clamp provides 360° orientation of the multiport valve for simple installation and service
- Hydraulically balanced flow distribution, to maximise filtration and backwashing
- Enhanced water clarity
- Pressure rated at 350 kPa
- Corrosion and UV resistant



SAVE ENERGY



SAVE TIME



SAVE WATER



enviropro
SAVE TIME, WATER AND ENERGY

www.waterco.com

Superior Strength

Exotuf Plus filters are considered one of the strongest filters within its class. Its filter vessel is precision injection moulded within minimal tolerances for enhanced structural strength and dependability. Pressure rated at 350 kPa, they are ideal for pools equipped with in-floor cleaning and high powered pumps.

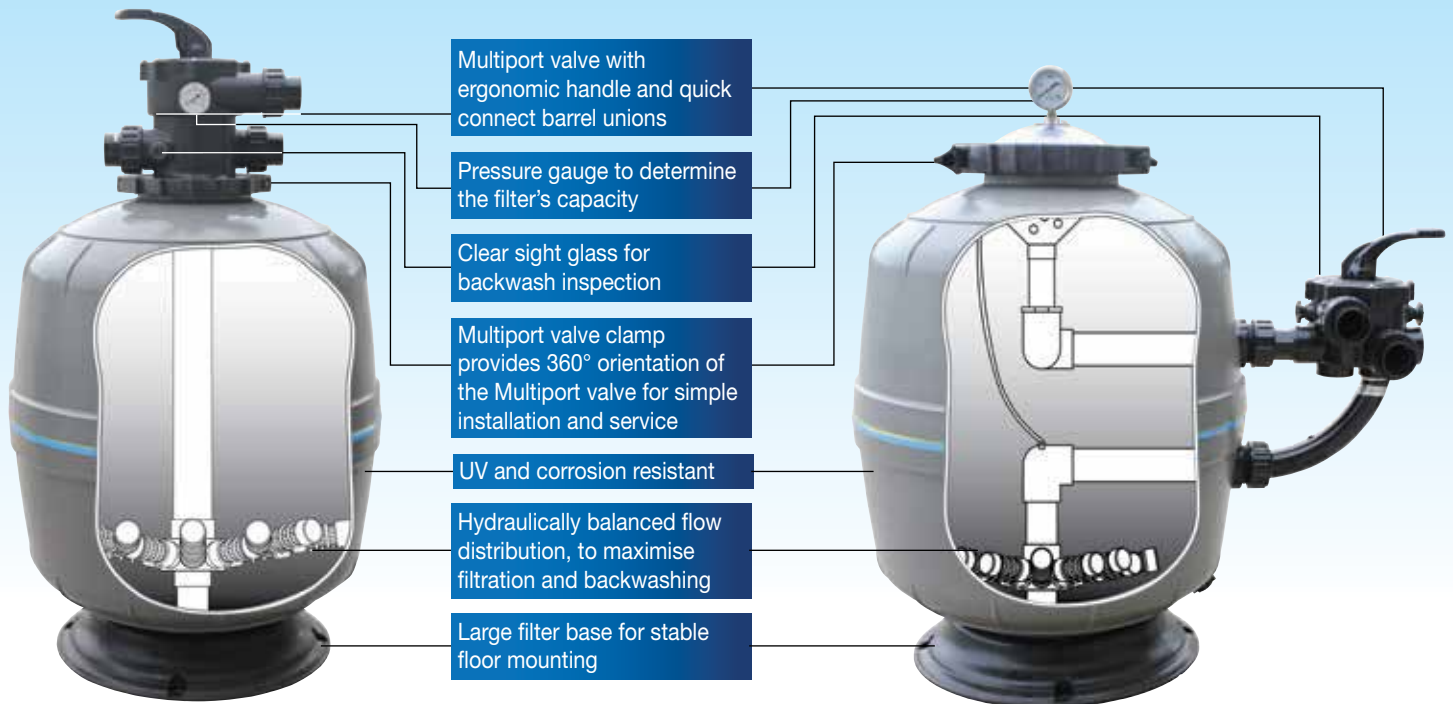

Maximum working temperature of 50°C

Depth Filtration

The Exotuf Plus filters operates on the basis of "Depth Filtration"; dirt is driven through the filter bed and trapped in minute spaces between the particles of filter media allowing the cleansed water to pass through the filter's laterals and exit via the filter's Multiport valve.

Ease of Maintenance

Cleansing the filter simply requires turning the filter's multiport lever from the "filter" position to the "backwash" position, which reverses the flow of water in the filter, flushing the filter bed.

Top Mount Configuration

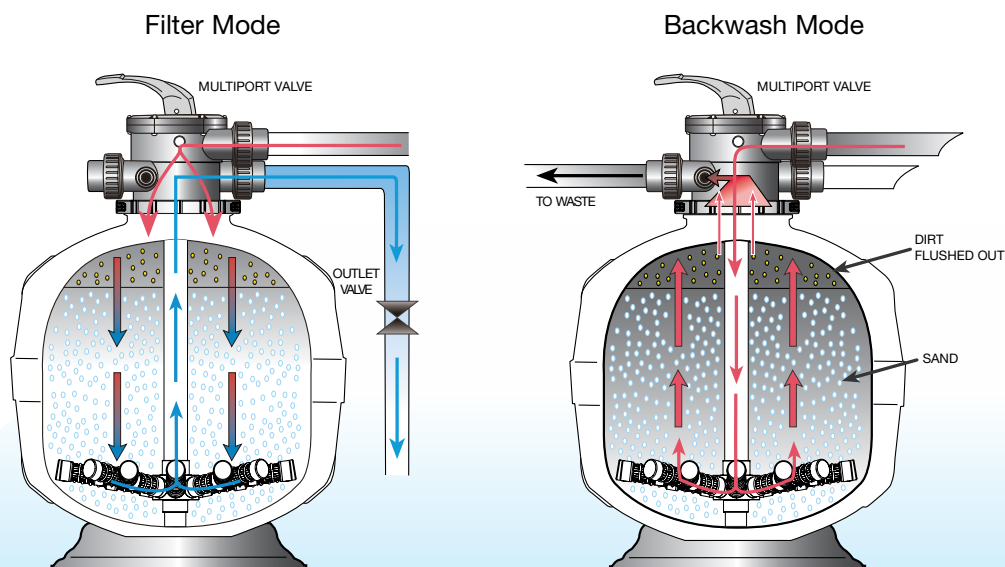

Water Saving “Fish Tail” laterals

Exotuf Filters are equipped with “Fish Tail” laterals, to improve its filtration and backwashing hydraulic efficiency.

Fish Tail laterals provide effective coverage of the filter bed and balanced water flow, during backwashing.

Exotuf Filters backwash time is significantly reduced, leading to a 30% savings of backwash water.

Energy Saving “Fish Tail” laterals

The Exotuf Filters hydraulic efficiency halves the backwash flow rate of a conventional sand filter, allowing the option for low powered, energy efficient pumps for filtration flow and backwash flow.

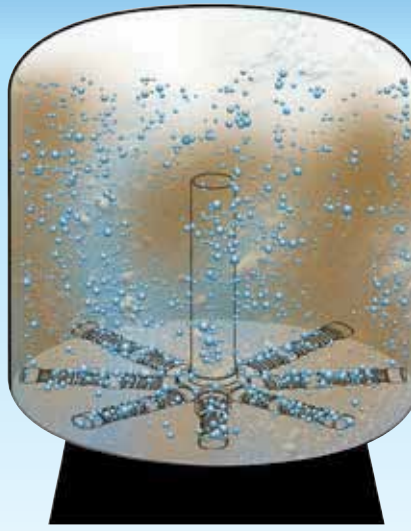

Conventional filter lateral system

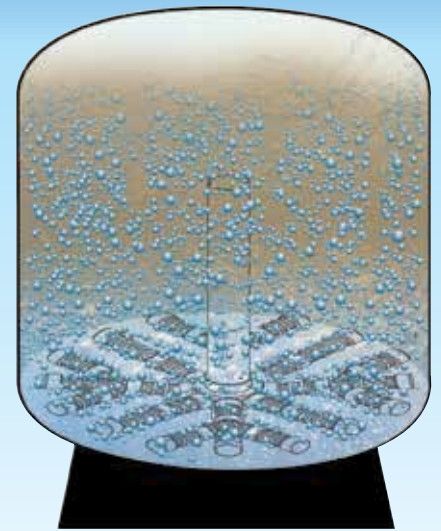

Exotuf Plus Fish Tail lateral system

Enhanced Water Clarity

Lowering a filter’s flow rate not only significantly decreases the pump’s energy requirements, but also reduces water flow resistance in your pool equipment and plumbing.

A lower flow rate also has the added benefit of enhancing your pool’s filtration efficiency, greatly enhancing the clarity of your swimming pool water.



Side Mount Configuration

Filter Mode

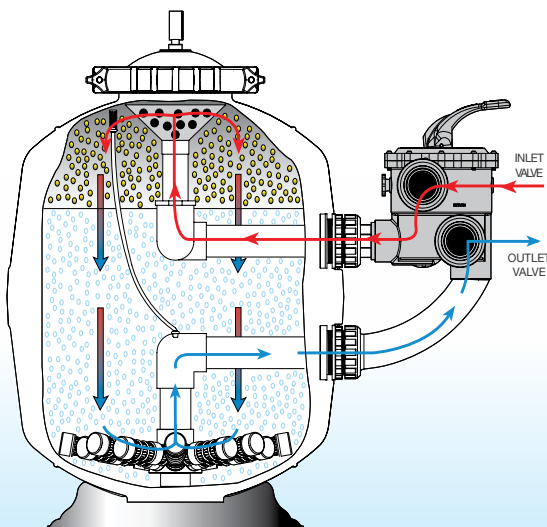

Backwash Mode

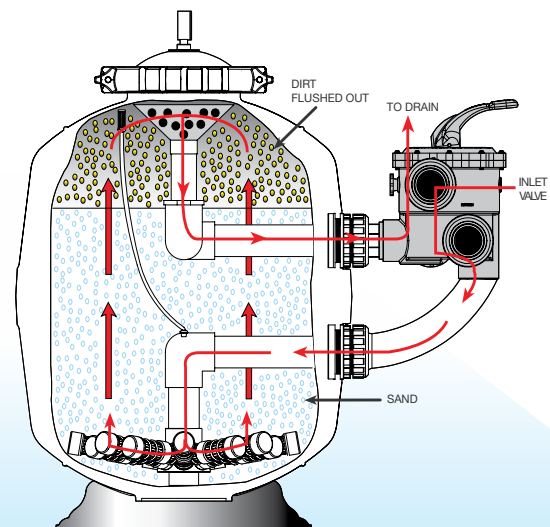

Technical Specification

Model No.	Valve Size (mm)	Inner Dia. (mm)	Filter Area (sq.m ²)	Bed Depth (mm)	Max. Flow* (lpm)	Max. Pool Size (litres)	Min. Backwash (lpm)	Media Volume (litres)	Glass Pearl (kg)	Sand 16/30 (kg)	Zeolite 1 - 2.2 (kg)
E600 Plus	40	600	0.28	360	226	81,360	189	120	194	175	144
E602 Plus	50	600	0.28	360	226	81,360	189	120	194	175	144
E702 Plus	50	700	0.38	430	308	110,800	257	185	298	270	222

Dimension (mm)

Model	Valve Size	A	B	C	D	E	F	G	H	V	K
E600 Plus	40	1095	635	484	182	809	953	862	88	706	115
E602 Plus	50	1148	635	484	220	824	1002	902	88	706	115
E702 Plus	50	1226	755	620	220	902	1080	980	90	805	145

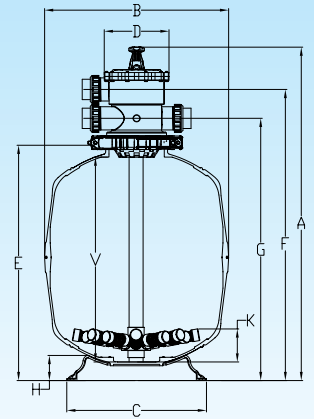

Technical Specification

Model No.	Valve Size (mm)	Inner Dia. (mm)	Filter Area (sq.m ²)	Bed Depth (mm)	Max. Flow* (lpm)	Max. Pool Size (litres)	Min. Backwash (lpm)	Media Volume (litres)	Glass Pearl (kg)	Sand 16/30 (kg)	Zeolite 1 - 2.2 (kg)
E600 Plus	40	600	0.28	360	226	81,360	189	120	194	175	144
E602 Plus	50	600	0.28	360	226	81,360	189	120	194	175	144
E702 Plus	50	700	0.38	430	308	110,800	257	185	298	270	222

Dimension (mm)

Model	Valve Size	A	B	C	W	R	P	E	F	K	V	H	L	X	Y	Z	J	S	T
E600 Plus	40	498	635	954	270	213	135	537	591	115	706	670	88	897	735	824	484	537	224
E602 Plus	50	502	635	954	292	220	149	537	639	115	706	670	88	897	796	824	484	537	334
E702 Plus	50	558	755	1031	292	220	149	545	647	145	805	770	90	974	804	902	620	454	342

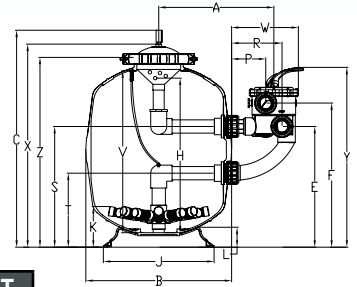

Residential flow rate based on a velocity of 48m³/hr/m². Max. pool size is based on a 6hr turnover.

Warranty

Exotuf Filters	10 Years (conditional)
Filter Tank	10 Years
Multi Port Valve & Other components	1 Year

Commercial Installations	5 Years (conditional)
Filter Tank	5 Years (1 year full + 4 years pro rata)
Multi Port Valve & Other components	1 Year

Please refer to Waterco's warranty terms and conditions



Rainbow Pool Products

PO Box 2388, Mansfield Qld 4122

Telephone STD 61-7-3849 5385

Facsimile STD 61-7-3849 5384

Email: info@rainbowpoolproducts.com.au

Web: www.rainbowpoolproducts.com.au