

DAVEY ECO PURE HIGH PERFORMANCE CARTRIDGE FILTERS



Code	Description
Q2201MN	50 ft2 Cartridge Filter
Q2202MN	75 ft2 Cartridge Filter
Q2203MN	100 ft2 Cartridge Filter
Q2204MN	150 ft2 Cartridge Filter

Replacement Cartridges

Q2225	50 ft2 Replacement EcoPure Filter Cartridge
Q2226	75 ft2 Replacement EcoPure Filter Cartridge
Q2227	100 ft2 Replacement EcoPure Filter Cartridge
Q2228	150 ft2 Replacement EcoPure Filter Cartridge

EcoPure®

High Performance Cartridge Filters

For maintaining a clean and safe swimming environment for your family's pool or spa with minimal water wastage



Features & Benefits

- Compact, durable A.B.S. tank with UV resistance for long service life
- Easy access to cartridge element via heavy duty locking ring
- Auto pressure release preventing damage to pump and filter should filter become blocked
- Quick connect 40mm A.B.S. barrel unions supplied for ease of installation
- Auto air bleed for removal of trapped air inside filter eliminating the need for manual bleeding
- No backwashing of filter required
- Quality pressure gauge makes it easy to see when element cleaning is required
- Cartridge element constructed of Du Pont Reemay – recognised for its excellent filtration and long life
- Suitable for all pools and spas, fresh or salt water







2 year Tank Guarantee



monarchseries.com.au

High Performance Cartridge Filters



-  Quality pressure gauge for monitoring of filtration performance
-  Automatic air bleed purges trapped air during filtration
-  High quality Du Pont polyester mesh with pleats for easy cleaning and long filtration cycles
-  A.B.S. tank construction is robust, UV resistant and corrosion resistant for long service life
-  A.B.S. barrell unions for quick connection and easy installation
-  Automatic pressure relief valve prevents internal pressures exceeding safe levels

Model	Filtration Area (sq metres)	Filtration Area (sq feet)	Max Flow Rate (lpm)	6 Hour Turnover (litres)	8 Hour Turnover (litres)
EcoPure 50	4.75	50	230	83,000	110,400
EcoPure 75	7	75	325	117,000	156,000
EcoPure 100	9.5	100	400	144,000	192,000
EcoPure 150	14.25	150	490	176,400	235,200

OPERATING LIMITS

Maximum Water Temperature	45°C
Maximum Operating Pressure (kPa)	280

DIMENSIONS (mm)

Model	A	B	C	D	Inlet/Outlet P.V.C.	Union Supplied
EcoPure 50	270	60	540	875	50	40
EcoPure 75	270	60	540	875		
EcoPure 100	270	60	635	1000		
EcoPure 150	270	60	820	1360		

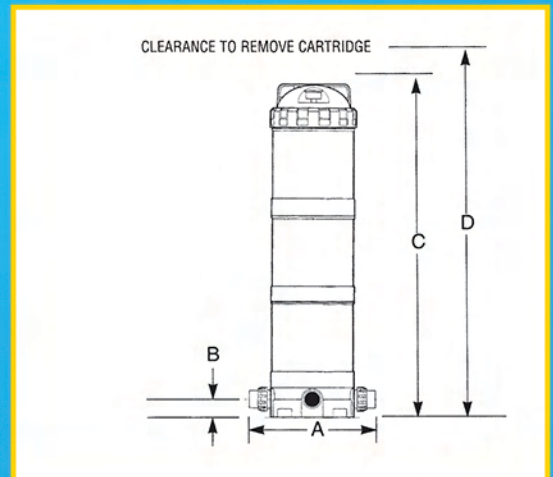

Datasheet Disclaimer:

All details in this leaflet are accurate at the time of printing. This literature is not a complete guide to product usage. Further information is available from your Monarch Series dealer, Davey Customer Service Centre and from the relevant product Installation & Operating Instructions. This datasheet must be read in conjunction with the relevant Installation & Operating Instructions and all applicable statutory requirements. Product specifications may change without notice. © Davey and EcoPure are registered trademarks of Davey Water Products Pty Ltd. © Davey Water Products Pty Ltd 2008.

Davey Water Products Pty Ltd

Member of the GUD Group
ABN 18 066 327 517

