



PAL Mini

With Colour Touch Technology,
warm white and cool white for both
in and out of water applications

FEATURES:



16mm drill
hole & 20mm
PVC conduit



Colour touch &
switch modes
available



RF control



Wi-Fi control-
apps available



Even glow,
no shadow



Approved to
IEC/AS/NZ

PAL

Mini

Versatile components:



Bollards



**Adjustable
Up Lights**

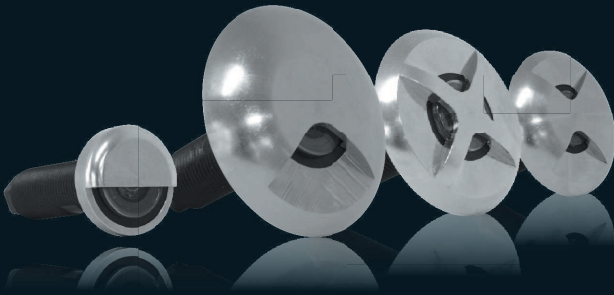

Hood and Driveway Covers

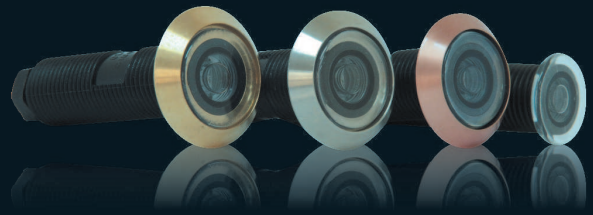

Surrounds

The beauty of the PAL Mini is that it is so tiny it is virtually unnoticeable, yet it will light up any step, ledge, swim out, beach entry, water feature, decking, garden or any surroundings you desire.

ACCESSORIES

Garden stake for adjustable base and bollard
Nylon nut for hoods, driveway covers and surrounds
Junction boxes – garden/underwater

PAL Mini

FEATURES

Compact size

Available in long life cool white, warm white and Colour Touch which allows you to choose from a spectrum of colours

Low, 1watt power consumption

All moulded construction

VOLTAGE

RGB Colour	12volts DC PAL Driver use only
Cool White	12volts AC/DC
Warm White	12volts AC/DC

LIGHT BEAM

180 degrees

APPROVAL

Approved to IEC/AS/NZ

INSTALLATIONS

16mm drill hole
20mm PVC conduit
41-WF1 fitting for fibreglass or concrete

LED SOURCE

RGB Colour	1watt
Cool White	1watt
Warm White	1watt

CABLE CORE AND LENGTHS

RGB Colour	4 Core 3m, 10m, 20m
Cool White	2 Core 3m, 10m, 20m
Warm White	2 Core 3m, 10m, 20m

RATING

Totally aquatic for underwater or out of water use

DIMENSIONAL DETAILS

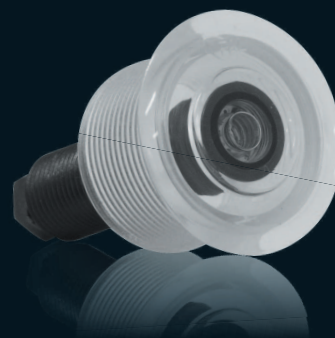
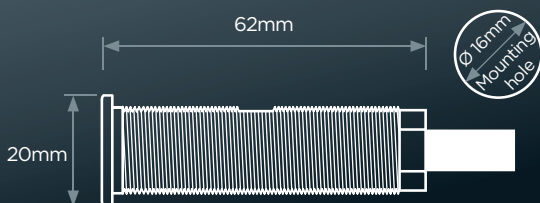

PAL MINI MOUNTING METHODS

WALL

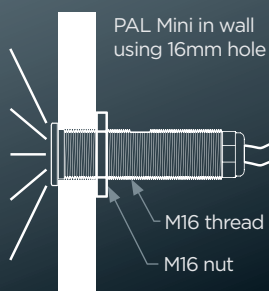

DECK

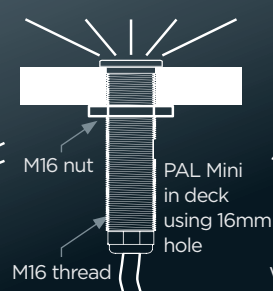

20MM RIGID PVC CONDUIT FOR FIBREGLASS

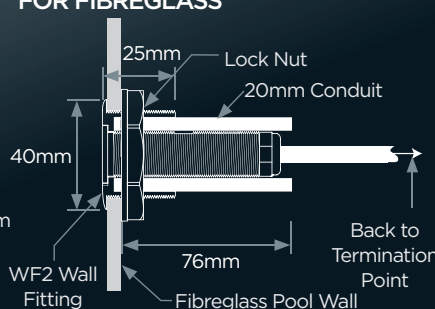

20MM RIGID PVC CONDUIT FOR CONCRETE

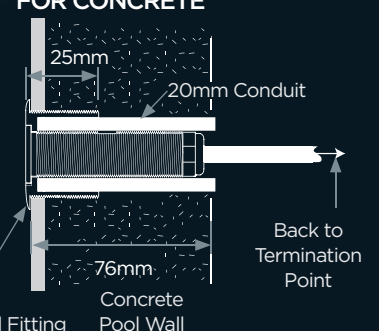

PAL

Mini

Colour Control

Control colour, speed, brightness and modes

Wireless Touch

Wi-Fi tablets and smartphones

Colour Touch Technology

Memory Recall

Remembers last colour, speed and brightness

Auto Sync

Automatic sync of your PAL lights every time

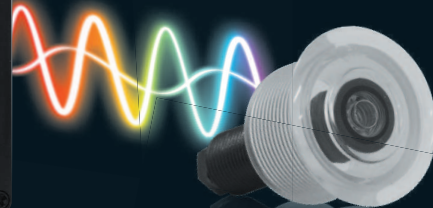

APPLE OR ANDROID DEVICES

Operating dist: 50 - 70metres

RF HANDSET

Part No: PCT-1
Operating dist: 50 - 70metres

RECEIVER/DRIVER

Part No: PCR-4U
50watts / 12volts
Wi-Fi and RF
IP 65
Approved to IEC/AS/NZ

PAL MINI

Approved to IEC/AS/NZ

ACCESSORIES

Garden stake for adjustable base and bollard
Nylon nut for hoods, driveway covers and surrounds
Junction boxes - garden/underwater

System Link

Allows you to link multiple systems for home and pool automation

RGB PAL-MINI LED LIGHT PART NUMBERS

Description	Code
RGB LED light and 3metre lead	41-PCL20M03
RGB LED light and 10metre lead	41-PCL20M10
RGB LED light and 20metre lead	41-PCL20M20

WHITE PAL-MINI LED LIGHT PART NUMBERS

Description	Code
Cool white LED light and 3metre lead	41-PCL20W03
Cool white LED light and 10metre lead	41-PCL20W10
Cool white LED light and 20metre lead	41-PCL20W20
Warm white LED light and 3metre lead	41-PCL20WW03

PAL-MINI ACCESSORIES PART NUMBERS

Description	Code
Nylon Nut	41-PCL20NN
WF2 20mm Conduit Adaptor	41-WF2
Black Cover Ring	41-PCL20CB
White Cover Ring	41-PCL20CW
316 S/S Cover Ring	41-PCL20CS
316 S/S Hood Cover	41-PCL20HS
316 S/S Driveway Hood Cover - 1 Slot	41-PCL20DHS1
316 S/S Driveway Hood Cover - 2 Slot	41-PCL20DHS2
316 S/S Driveway Hood Cover - 4 Slot	41-PCL20DHS4
Aluminium Bollard Kit	41-PCL20BL
Adjustable Base	41-PCL20B
Garden Stake for Adjustable Base	41-PCL20GS
JB-3 2 Way Junction Box for White (Garden) IP65	41-JBG32
JB-3 4 Way Junction Box for RGB (Garden) IP65	41-JBG34



APPLE AND ANDROID APPS AVAILABLE AT ITUNES AND GOOGLE PLAY